



**6100 Series
Portable Stand-On
Patient Scale
Operation Manual**

INTRODUCTION

Thank you for purchasing our 6100 Series Portable Stand-On Patient Scale. It has been manufactured with quality and reliability at our factory in Webb City, MO USA of American and global components and is TAA compliant. Your scale has been tested before leaving our factory to ensure accuracy and dependability for years to come.

This manual is provided to guide you through the operation of your scale. Please read it thoroughly before attempting to operate your scale and keep it available for future reference.

This manual is for use with the following 6100 Series Portable Stand-On Patient Scale models: 6100, 6100-AC, 6100-C, 6100-C-AC

COPYRIGHT

All rights reserved. Reproduction or use, without express written permission, of editorial or pictorial content, in any manner, is prohibited. No patent liability is assumed with respect to the use of the information contained herein.

DISCLAIMER

While every precaution has been taken in the preparation of this manual, the Seller assumes no responsibility for errors or omissions. Neither is any liability assumed for damages resulting from the use of the information contained herein. All instructions and diagrams have been checked for accuracy and ease of application; however, success and safety in working with tools depend to a great extent upon individual accuracy, skill, and caution. For this reason, the Seller is not able to guarantee the result of any procedure contained herein. Nor can they assume responsibility for any damage to property or injury to persons occasioned from the procedures. Persons engaging in the procedures do so entirely at their own risk.



FCC COMPLIANCE STATEMENT

This equipment generates, uses, and can radiate radio frequency, and if not installed and used in accordance with the instruction manual, may cause interference to radio communications. It has been designed within the limits for a Class A computing device pursuant to Subpart J of Part 15 of FCC rules to provide reasonable protection against such interference when operated in a commercial environment. Operation of this equipment in a residential area may cause interference in which case the user will be responsible to take whatever measures necessary to correct the interference.

You may find the booklet "How to Identify and Resolve Radio-TV Interference Problems" prepared by the Federal Communications Commission helpful. It is available from the U.S. Government Printing Office, Washington, D.C. 20402. Request stock No. 001-000-00315-4.

Serial Number _____
Date of Purchase _____
Purchased From _____

RETAIN THIS INFORMATION FOR FUTURE USE

PRECAUTIONS	
Before using this scale, read this manual and pay special attention to all "NOTIFICATION" symbols:	
	
IMPORTANT	ELECTRICAL WARNING

PROPER DISPOSAL

When this device reaches the end of its useful life, it must be properly disposed of. It must not be disposed of as unsorted municipal waste. Within the European Union, this device should be returned to the distributor from where it was purchased for proper disposal. This is in accordance with EU Directive 2002/96/EC. Within North America, the device should be disposed of in accordance with the local laws regarding the disposal of waste electrical and electronic equipment.

It is everyone's responsibility to help maintain the environment and to reduce the effects of hazardous substances contained in electrical and electronic equipment on human health. Please do your part by making certain that this device is properly disposed of. The symbol shown to the right indicates that this device must not be disposed of in unsorted municipal waste programs.



BATTERY CAUTION



CAUTION: RISK OF EXPLOSION IF BATTERY IS REPLACED BY AN INCORRECT TYPE. DISPOSE OF USED BATTERIES ACCORDING TO THE INSTRUCTIONS.

ATTENTION: RISQUE D'EXPLOSION SI LA BATTERIES EST REMPLAC'E PAR UN TYPE INCORRECT. REJETEZ LES BATTERIES UTILISE'ES SELON LES INSTRUCTIONS.

TRANSPORTATION AND STORAGE



Do Not Drop



Handle with Care



Keep Dry

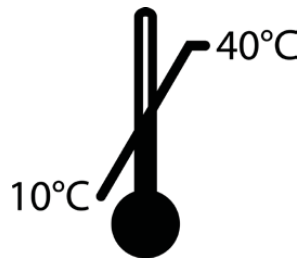

Temperature Range

TABLE OF CONTENTS

SPECIFICATIONS	Page 1
STANDARD FEATURES	Page 1
UNPACKING	Page 1
SCALE PREPARATION	Page 2
WEIGHING UNITS SELECTION	Page 3
OPERATING INSTRUCTIONS	Page 4
Basic Weighing Operation	Page 4
To Weigh	Page 4
Zero Weight Display	Page 4
Body Mass Index (BMI) Operation	Page 5
To Weigh and Calculate BMI	Page 5
Weigh Recall	Page 5
Serial ID Storage	Page 5
ERROR AND STATUS DISPLAYS	Page 6
BEFORE YOU CALL SERVICE	Page 6
PART IDENTIFICATION	Page 7

CARE AND CLEANING



The 6100 Series Portable Patient Scale contains no user-serviceable parts and maintenance should be limited to occasional cleaning and battery replacement as required.

- Do not submerge the scale or weight indicator in water, pour, or spray water directly on them to clean. The scale and weight indicator are not waterproof and covering them with water will damage it and void the warranty.
- Always remove power before cleaning. i.e., Remove the AC power adapter cord from the weight indicator or remove the batteries.
- Do not use wire brushes, abrasives, or cleaning tools such as steel pads and scrapers, which will scratch the painted surface. Instead, use soft cloths or plastic scouring pads for cleaning.
- When possible, use treated water. Hard water can leave behind deposits. Soft water is much gentler on the painted steel's surface.
- Avoid the use of acetone, thinner or other volatile solvents, and abrasive-type cleaners for cleaning. If required, a mild solvent such as mineral spirits can be used to remove oil, grease, tars, wax, and similar substances. Use a cloth dampened with mineral spirits and apply only to areas that are contaminated. Follow up the use of this mild solvent with detergent cleaning and rinsing.

SPECIFICATIONS

Capacity:	800 lb x 0.2 lb (360 kg x 0.1 kg)
Platform Size:	18 in W x 14 in D x 2 in H (46 cm W x 36 cm D x 6 cm H)
Construction:	Steel powder coated painted white with slip-resistant rubber mat
Cable Length:	15 ft (4.5 m) from scale base to indicator
Indicator Size:	6.125 in W x 6.75 in H x 1.75 in D (16 cm W x 17 cm H x 4 cm D)
Display:	Six-digit, Seven segments, 0.7 inch (19 mm) high LCD
Keyboard:	Membrane type with 5 keys, On/Off, Lock/Release, Print, Zero, Height/Enter, and 4 directional arrows
Power:	6 AA Alkaline, Ni-Cad or NiMH batteries (<i>not included</i>) OR 100 to 240V AC 50/60Hz 12V DC 1A wall plug-in UL/CSA listed AC power adapter (Cardinal part number 6800-1045) included on -AC models
Connectivity:	RS232 serial port standard. Wi-Fi and Bluetooth models are available for wireless EMR/EHR connectivity on -C models
Indicator Features:	Units Locking, Auto Shut-Off, Selectable Sleep Mode, Selectable Filtering, Serial I/O (Input/Output)
Operating Temperature:	14 to 104 °F (-10 to +40 °C)
Shipping Weight:	31 lb (14 kg)
Country of Origin:	Made in the USA (of American and global components)

STANDARD FEATURES

- Portable stand-on patient scale with integral carrying handle and remote indicator
- Bubble level helps you find a level weighing foundation for optimal accuracy
- 15 ft / 4.5 m long cable from the scale base to the weight indicator
- The indicator can be placed on a nearby tabletop, counter, or floor
- Versatile indicator mounting bracket included for portable countertop or permanent wall mounting use
- Non-skid black rubber mat for patient safety
- Powered by 6 AA batteries for ultra-portability
- -AC models include the AC power adapter (Cardinal part number 6800-1045)
- BMI (Body Mass Index) calculation
- Lock/Release key can hold weights and BMI calculation
- Weight Recall
- Serial ID Storage

UNPACKING INSTRUCTIONS

The 6100 Series Portable Patient Scale is shipped in two (2) cartons. One carton will contain the weight indicator and the other carton will house the portable scale base (with the 15 ft. coiled cable), the versatile desk stand/wall mounting bracket for the weight indicator, and the AC power adapter if the scale is an -AC model.

Before beginning the installation, please carefully unpack the scale and weight indicator and remove all wrappings and fillers. Inspect both for any signs of damage due to shipping, such as exterior dents and scratches. It is the responsibility of the Purchaser to file all claims for any damages or loss in transit incurred. Retain all packing and the shipping carton for return of scale if necessary.

SCALE PREPARATION

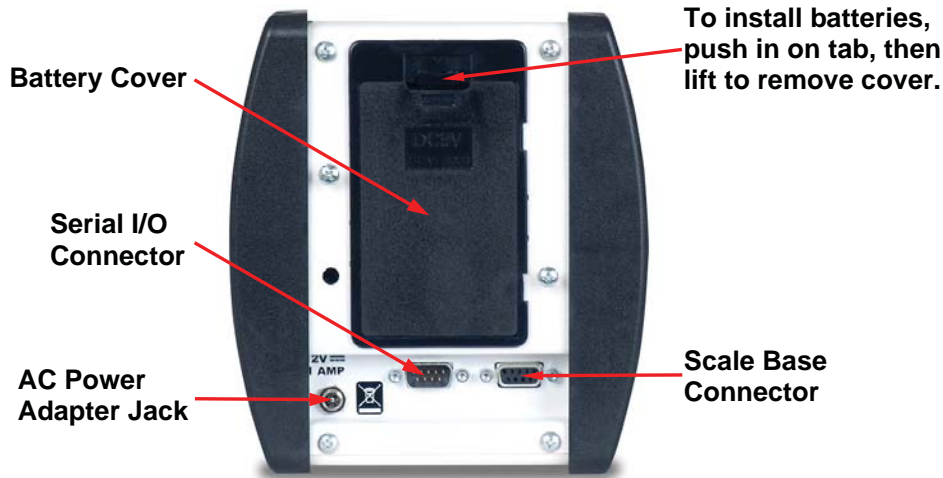

1. Obtain and install six AA alkaline, Ni-Cad, or NiMH batteries or if a -AC model, plug the small connector end of the AC power adapter cord into the AC power adapter jack located in the bottom right corner at the back of the weight indicator and then plug the AC power adapter into the proper electrical outlet.



CAUTION! The weight indicator can be operated from Alkaline, Ni-Cad, or NiMH batteries. All six batteries must be of the same type. They must all be Alkaline, all Ni-Cad, or all NiMH. **DO NOT** mix Alkaline and Ni-Cad or NiMH batteries.



WARNING! The AC power adapter is also used to recharge the batteries when the weight indicator is operated from Ni-Cad or NiMH batteries. **DO NOT** connect the AC power adapter to the weight indicator if using Alkaline batteries. Also, when using Alkaline batteries, make sure the *n i C a d* setup option is disabled (set to 0). Refer to *Setup and Calibration* or *Setup Review* sections of the *750 Weight Indicator Owner's Manual, 8555-M483-O1*.

2. The scale base connection to the weight indicator is made via a 15 ft. cable with a 9-pin "D" type connector on the end. This connector plugs into the 9-pin "D" type jack (scale base connector) located on the bottom right rear panel of the indicator and is secured by two (2) screws.
3. Next, install the weight indicator on the mounting bracket. Place the screw heads on the back of the indicator into the large end of the slotted holes in the mounting bracket and pull down to secure the indicator. The spring plunger will lock the indicator to the bracket.
4. Place the scale on a flat, level floor, or low-cut carpet away from heating and cooling vents.
5. Place the weight indicator in a convenient location away from the scale base. The location should be where it is easily viewed and within reach of the operator.
6. The 6100 Series Portable Patient Scale is now ready for operation.



NOTE: For more information on installing batteries (or the AC power adapter), connecting the scale base cable to the weight indicator, installing the mounting bracket on the weight indicator, or setup, refer to the *750 Weight Indicator Owner's Manual, 8555-M483-O1*.

WEIGHING UNITS SELECTION

When the 750 Weight Indicator on the 6100 Series Portable Patient Scale is turned on for the *first* time, it will display a prompt to select the weighing units to use for your operation, lb (pounds) or kg (kilograms). The weighing units selection can **ONLY** be made at this time and cannot be changed afterward. Make sure you select the correct weighing units before proceeding.

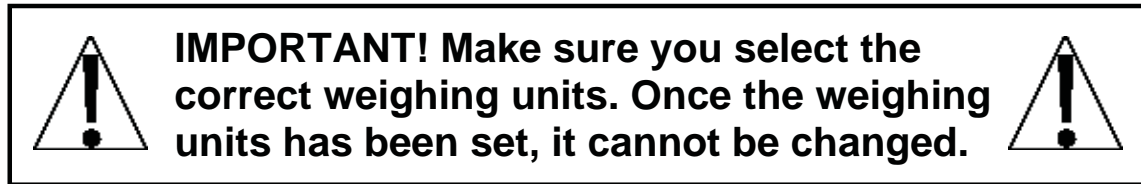

Key Used for Weighing Units Selection

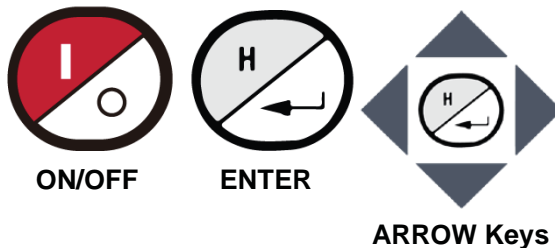

1. Press the **ON/OFF** key to turn the 750 Weight Indicator on.
2. The display will show the model number, then the software version for a few seconds, and will finally change to show *Unit =*.
3. Press the **ENTER** key to view the current (factory) setting.
4. The display will change to show a flashing *l* with the lb (pounds) annunciator turned on next to it.
5. If weighing in lb (pounds) is required for your operation, press the **ENTER** key to save it, and then proceed to step 12.
6. If your operation requires weighing in kg (kilograms), press the **▲** (UP arrow) key to select kilograms.
7. The display will change to show a flashing *k* with the kg (kilograms) annunciator turned on next to it.
8. Press the **ENTER** key to save the kg (kilograms) weighing units setting, and then proceed to step 12.
9. If your operation requires weighing in lb-oz (pounds and ounces), press the **▲** (UP arrow) key again to select pounds and ounces.
10. The display will change to show a flashing *5* with the lb-oz (pounds and ounces) annunciator turned on next to it.
11. Press the **ENTER** key to save the lb-oz (pounds and ounces) weighing units setting, and then proceed to step 12.
12. The 750 Weight Indicator for the 6100 Series Portable Patient Scale is ready for operation.

OPERATING INSTRUCTIONS



DO NOT operate the keypad with pointed objects (pencils, pens, etc.). Damage to the keypad resulting from this practice is **NOT** covered under the warranty.



Key Legend



ON/OFF

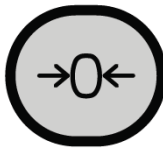

ZERO

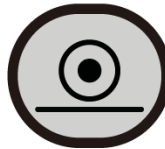

PRINT



**LOCK
RELEASE**

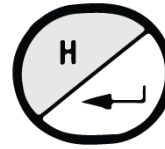

**HEIGHT
ENTER**

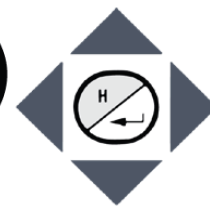

ARROW Keys

Basic Weighing Operation

To Weigh

1. Press the **ON/OFF** key to turn on the weight indicator.
2. If required, press the **ZERO** key to zero the weight display.
3. Assist the patient on the scale.
4. When the weight is stable, the **▲▲** annunciator will turn on. Read the weight display.
5. If a printer is connected to the scale, press the **PRINT** key to print a ticket.
6. Assist the patient off the scale.

Zero Weight Display

1. In the Gross Weight mode (GROSS annunciator on), press the **ZERO** key.
2. The weight display will return to zero. The ZERO and STABLE **▲▲** annunciators will turn on to show a stable, center-of-zero (→0←) gross weight condition.













NOTE: For more information on the operation of the 750 Weight Indicator, refer to the 750 Weight Indicator Owner's Manual, 8555-M483-O1.

OPERATING INSTRUCTIONS, CONT.



Body Mass Index (BMI) Operation



To Weigh and Calculate BMI

1. Press the **ON/OFF** key to turn on the weight indicator.
2. If required, press the **ZERO** key to zero the weight display.
3. Assist the patient on the scale.
4. When the weight is stable (STABLE  annunciator will turn on), read the weight display.
5. Press the **HEIGHT** key.
6. If pounds was selected for the weighing units, the display will change to show 5 FEET, 5 INCHES with the 6 blinking. (*The blinking character is the position to be changed*).
 - a. Press the  or  keys until the desired height in inches is displayed.
 - b. Press the  or  key to move the blinking character to FEET.
 - c. Press the  or  keys until the desired height in feet is displayed.
 - d. Proceed to Step 8.
7. If kilograms was selected for the weighing units, the display will change to show 170 cm. with the 0 of 170 blinking. (*The blinking character is the position to be changed*).
 - a. Press the  or  keys until the desired number is displayed.
 - b. Press the  or  key to move to the next character to change.
 - c. Repeat steps A and B until the desired height in centimeters is displayed.
 - d. Proceed to Step 8.
8. Press the **HEIGHT** key.
9. Read the BMI on the display.
10. If a printer is connected to the scale, press the **PRINT** key to print a ticket.
11. Assist the patient off the scale.
12. Press the **HEIGHT** key to return to the normal weighing operation.

NOTE: The **HEIGHT** key can be used to toggle between the calculated BMI value and the weight until the scale goes below 10% of capacity (80 lbs). At that point, a new height input is required.

Weight Recall

During normal operation, pressing the  or  keys will enter a weight recall option that allows the last 10 weights recorded to be reviewed. *Note that the weight is recorded each time the weight is locked.*

- Use the  or  keys to scroll through the 10 records.
- The **ZERO** key can be used to clear the recorded values.
- Press any other key to return the indicator to normal operation.

NOTE: While reviewing the recorded weights, the display will alternate between the transaction number and the weight. In addition, the 10 recorded weights can only be viewed and cannot be printed.

Serial ID Storage

The 750 Weight Indicator on the 6100 Series Portable Patient Scale has been equipped with Serial ID storage for 200 records. Each ID stores the ID index, Weight, Height, BMI, and Unit of measure. When the **ENTER** key is pressed, the indicator will assign the current values to a new ID and store the ID in memory. Next, the indicator will print the ticket in the mode selected during setup and calibration.

Once the first print is finished, the indicator will allow more tickets to be printed, however, it will not store the values again until the weight goes below 1/10 of the scale capacity. This prevents ID overlap until the next person steps on the scale. **NOTE:** Serial ID storage can only be printed, not viewed through the display.

ERROR AND STATUS DISPLAYS

Display	Meaning
-Err-	This is a general error, such as an invalid keypad entry being attempted.
-ouF-	The weight indicator is attempting to display a negative number greater than -99,999 or a positive number greater than 999,999
-tL-	This error indicates an attempt to zero a weight that is outside the scale zero range. (<i>Refer to the Four Percent Zero Tracking Range Limit setting in the 750 Weight Indicator Owner's Manual, 8555-M483-O1</i>).
-UnS-	This error indicates motion is present when the weight indicator is attempting to perform one of the following operations: Power Up Zero or Zero Weight Display.
CALib	This error indicates the scale requires calibration.
AdErr	} If these errors are displayed, you should consult your scale service representative.
ErrAL	
ErrAH	
OCAP	The scale weight exceeds the scale capacity.
OFF	This is displayed to indicate the weight indicator is turning off.

BEFORE YOU CALL FOR SERVICE

Problem	Possible Solutions
The display does not turn on	<p>AC Operation:</p> <ul style="list-style-type: none"> • Is the AC power adapter fully inserted into the wall outlet? • Check the wall outlet for proper AC power. Try another electrical appliance in the same outlet. Does it work? • Check the circuit breaker. • Has there been a power failure? <p>Battery operation:</p> <ul style="list-style-type: none"> • Check if the batteries are installed and match the polarity markings located in the battery holders. • One or more of the batteries may be improperly positioned. Ensure they are completely in the battery holder. • If using Alkaline batteries, remove the old batteries and replace them with new ones. • If using NI-CAD or NiMH batteries, remove the discharged batteries and replace them with fully charged batteries. Use an external charger to recharge the discharged batteries.
Incorrect weight is displayed	Make sure the scale platform is not touching an adjacent object. Have the proper operation procedures been followed?
Weight is not displayed	Refer to the Error and Operation Messages.

PART IDENTIFICATION

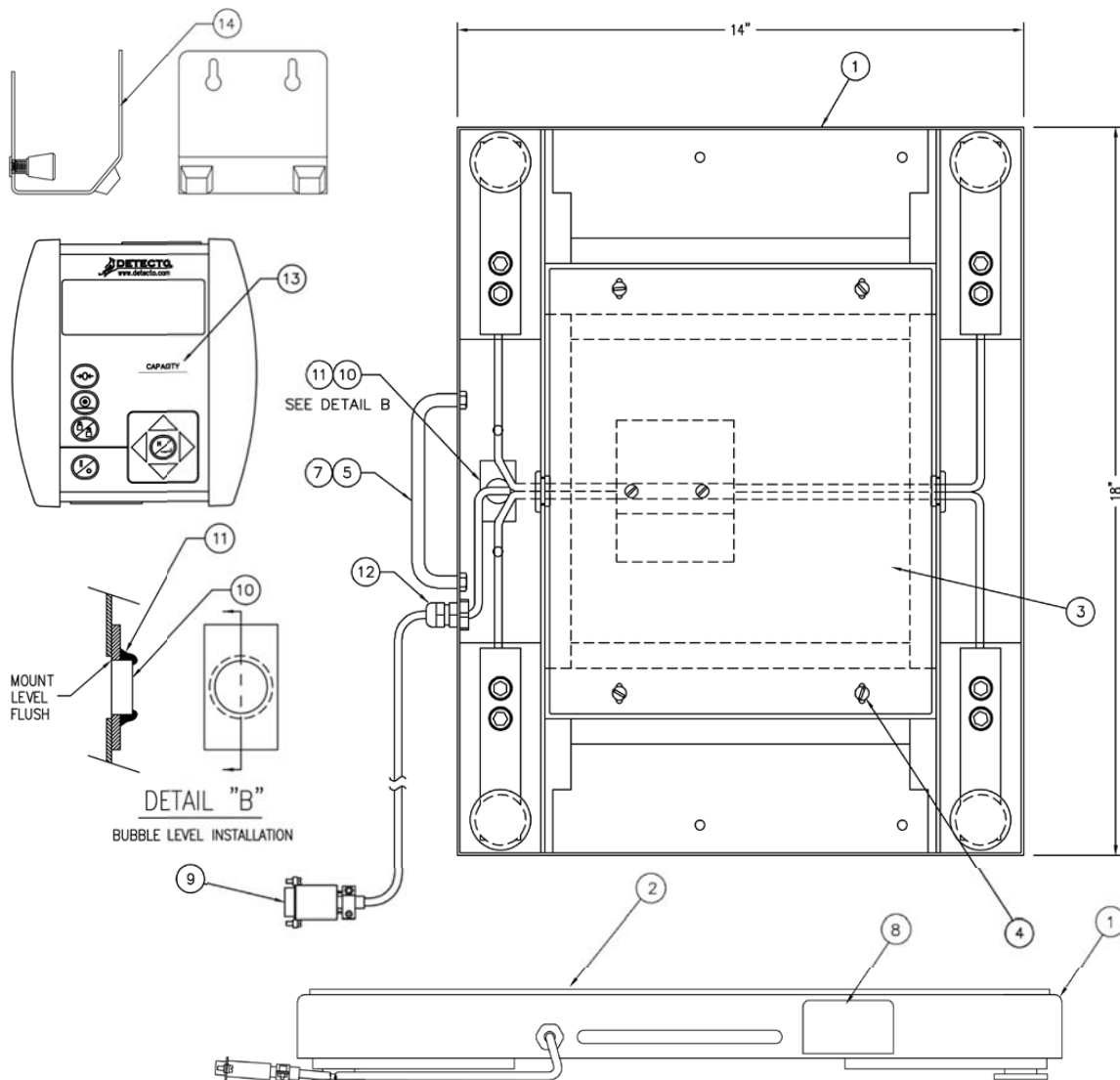

ITEM #	QTY	PART NUMBER	DESCRIPTION
1	1	1930-D330-0A	WEIGHBRIDGE ASSY
2	1	1930-C345-08	MAT W/ADHESIVE, 13.5" X 17.5"
3	1	1930-C337-08	COVER
4	2	6021-0665	MACHINE SCREW, #6-32 X 3/8 LONG
5	1	0044-B178-08	HANDLE
7	2	6021-1045	SCREW, #10-32 X 1/2" HEX HD MACH
8	1	593GR986	SERIAL TAG
9	1	0065-B246-0A	CABLE, 15 FT, 4 CONDUCTOR, 24GA, SHIELDED
10	1	6690-0001	LEVEL
11	A/R	6560-1047	ADHESIVE, J-B QUIK WELD
12	1	6610-1150	GLAND CONNECTOR
13	1	REF	750 WEIGHT INDICATOR, DIGITAL
14	1	0033-B440-0A	MTG BRKT ASSY FOR 750, DESK/WALL MOUNT
*	1	6800-1045	AC POWER ADAPTER: 100-240V AC/12V DC @ 1A

* NOT SHOWN

STATEMENT OF LIMITED WARRANTY

DETECTO warrants its equipment to be free from defects in material and workmanship as follows: DETECTO warrants to the original purchaser only that it will repair or replace any part of equipment which is defective in material or workmanship for a period of **two (2) years from date of shipment**. Detecto shall be the sole judge of what constitutes a defect.

During the **first ninety (90) days** DETECTO may choose to replace the product at no charge to the buyer upon inspection of the returned item.

After the first ninety (90) days, upon inspection of the returned item, DETECTO will repair or replace it with a remanufactured product. The customer is responsible for paying for the freight both ways.

This warranty does not apply to peripheral equipment not manufactured by DETECTO; this equipment will be covered by certain manufacturer's warranty only.

This warranty does not include replacement of expendable or consumable parts. This does not apply to any item which has deteriorated or damaged due to wear, accident, misuse, abuse, improper line voltage, overloading, theft, lightning, fire, water or acts of God, or due to extended storage or exposure while in purchaser's possession. This warranty does not apply to maintenance service. Purchased parts will have a ninety (90) day repair or replacement warranty only.

DETECTO may require the product to be returned to the factory; item(s) must be properly packed and shipping charges prepaid. A return authorization number must be obtained for all returns and marked on the outside of all returned packages. DETECTO accepts no responsibility for items lost or damaged in transit.

Conditions Which Void Limited Warranty

This warranty shall not apply to equipment which:

- A.) Has been tampered with, defaced, mishandled or has had repairs and modifications not authorized by DETECTO.
- B.) Has had serial number altered, defaced, or removed.
- C.) Has not been properly grounded according to Detecto's recommended procedure.

Freight Carrier Damage

Claims for equipment damaged in transit must be referred to the freight carrier in accordance with freight carrier regulations.

This warranty sets forth the extent of our liability for breach of any warranty or deficiency in connection with the sale or use of the product. DETECTO will not be liable for consequential damages of any nature, including but not limited to, loss of profit, delays or expenses, whether based on tort or contract. Detecto reserves the right to incorporate improvements in material and design without notice and is not obligated to incorporate improvements in equipment previously manufactured.

The foregoing is in lieu of all other warranties, express or implied including any warranty that extends beyond the description of the product including any warranty of merchantability or fitness for a particular purpose. This warranty covers only those DETECTO products installed in the forty-eight (48) contiguous continental United States.



Ph. (800) 641-2008
E-mail: detecto@cardet.com
102 E. Daugherty
Webb City, MO 64870

04/22/2024
Printed in USA
D268-WARRANTY-DET-B



DETECTO
102 E. Daugherty, Webb City, MO 64870 USA
Ph: 417-673-4631 or 1-800-641-2008
Fax: 417-673-2153
www.Detecto.com
Technical Support: 1-866-254-8261
E-mail: tech@cardet.com

Printed in USA

1930-0508-0M Rev A 05/23