

DETECTO®



Model 8432-CH
Pediatric Scale
with Inclined Chair Seat
Owner's Manual

COPYRIGHT

All rights reserved. Reproduction or use, without expressed written permission, of editorial or pictorial content, in any manner, is prohibited. No patent liability is assumed with respect to the use of the information contained herein.

DISCLAIMER

While every precaution has been taken in the preparation of this manual, the Seller assumes no responsibility for errors or omissions. Neither is any liability assumed for damages resulting from use of the information contained herein. All instructions and diagrams have been checked for accuracy and ease of application; however, success and safety in working with tools depend to a great extent upon the individual accuracy, skill and caution. For this reason, the Seller is not able to guarantee the result of any procedure contained herein. Nor can they assume responsibility for any damage to property or injury to persons occasioned from the procedures. Persons engaging the procedures do so entirely at their own risk.

PROPER DISPOSAL

When this device reaches the end of its useful life, it must be properly disposed of. It must not be disposed of as unsorted municipal waste. Within the European Union, this device should be returned to the distributor from where it was purchased for proper disposal. This is in accordance with EU Directive 2002/96/EC. Within North America, the device should be disposed of in accordance with the local laws regarding the disposal of waste electrical and electronic equipment.

It is everyone's responsibility to help maintain the environment and to reduce the effects of hazardous substances contained in electrical and electronic equipment on human health. Please do your part by making certain that the device is properly disposed of. The symbol shown to the right indicates that this device must not be disposed of in unsorted municipal waste programs.



FCC COMPLIANCE STATEMENT

This equipment generates uses and can radiate radio frequency and if not installed and used in accordance with the instruction manual, may cause interference to radio communications. It has been tested and found to comply with the limits for a Class A computing device pursuant to Subpart J of Part 15 of FCC rules, which are designed to provide reasonable protection against such interference when operated in a commercial environment. Operation of this equipment in a residential area may cause interference in which case the user will be responsible to take whatever measures necessary to correct the interference.

You may find the booklet "How to Identify and Resolve Radio TV Interference Problems" prepared by the Federal Communications Commission helpful. It is available from the U.S. Government Printing Office, Washington, D.C. 20402. The stock No. is 001-000-00315-4.

INTRODUCTION

The Detecto Model 8432-CH Pediatric Scale with Inclined Chair Seat is ideal for use in health clinics and medical practices for weight measurement of infants and tots. The scale has an easy to clean seashell-shaped plastic seat that can be mounted in three different directions for optimal comfort of the child, and a durable, sturdy enameled steel scale base.

This manual is provided to guide you through assembly and operation of your scale. Please read it thoroughly before attempting to assemble or operate your scale and keep it available for future reference.

This manual is for use with the following Digital Pediatric Scale models:

8432-CH, 8432-CH-AC, and 8432KG-CH

SPECIFICATIONS



Capacity	44 lb x 0.05 lb / 20 kg x 0.02 kg
Shipping Weight	33 lb (15 kg)
Scale Height	37.5 in (95.3 cm)
Display	Six-digit, seven segment, 0.7 inch (17.8 mm) high LCD
Power	Six "AA" Alkaline, Ni-Cad or NiMH batteries (<i>not included</i>) OR an optional 100 to 240V AC 50/60Hz 12V DC 1A wall plug-in UL/CSA listed AC power adapter (Cardinal part number 6800-1045). Models are available with the AC adapter included.
Keyboard	Membrane type with 5 keys and 4 directional arrows
Connectivity:	RS232 serial port

UNPACKING INSTRUCTIONS

- Remove scale from carton by lifting up with equal force from column and platform base.
- Remove all plastic wrapping, foam fillers and cardboard material from the scale.
- Place scale upside down on level, stable surface and remove all cardboard packing from bottom of scale base.
- Return scale to upright position and check for any damage incurred in shipping. If scale has been damaged, place a claim with the carrier. Use the original carton and shipping material to return the scale.
- Remove and unpack the AC power adapter, if the scale was ordered with this option.

Serial Number _____
Date of Purchase _____
Purchased Form _____

RETAIN THIS INFORMATION FOR FUTURE USE

PRECAUTIONS	
Before using this instrument, read this manual and pay special attention to all "WARNING" symbols:	
	
IMPORTANT	ELECTRICAL WARNING

SCALE ASSEMBLY

Column to Scale Base Installation

1. Insert the column onto the scale base (shown in Figure 1), ensuring that the narrow side of the column faces the scale platform.

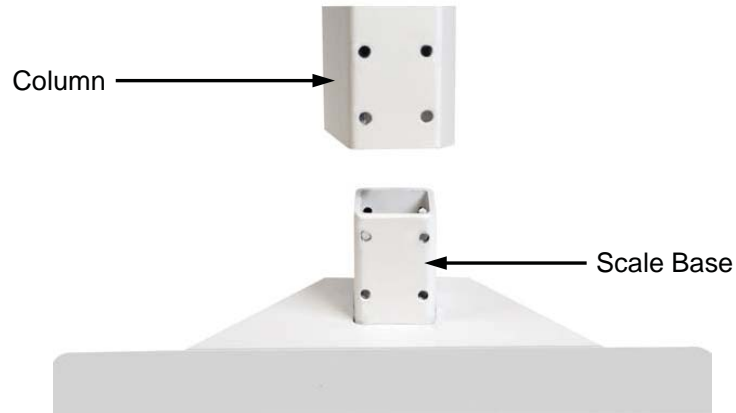

Figure 1. - Insert column onto scale base

2. Using a Phillips screwdriver, install the eight screws and washers to secure the column to the scale base as shown in Figure 2.



Figure 2. - Install eight screws and washers to secure column to scale base

SCALE ASSEMBLY, CONT.

Indicator Installation

First, install the scale cable on the indicator. Align the scale cable connector with the jack on the back of the indicator, then gently push the connector onto the jack. Refer to Figure No. 3 for the location of the scale cable jack.

Using a small flat blade screwdriver, tighten the screws on both sides of the scale cable connector.

Next, install the indicator on the scale column bracket by placing the screw heads on the back of the indicator into the large end of the slotted holes in the bracket.

Pull down on the indicator to secure it to the bracket. The spring plunger will lock the indicator to the bracket. See Figures No. 3, 4, and 5.

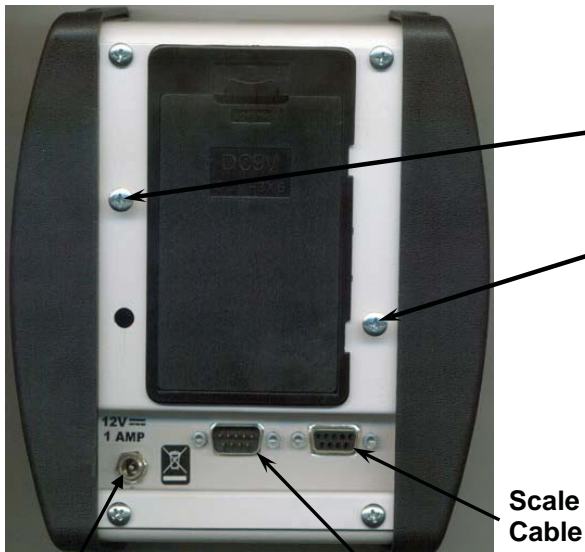

Figure No. 3

AC Power Adapter

Scale Cable

RS232 Port

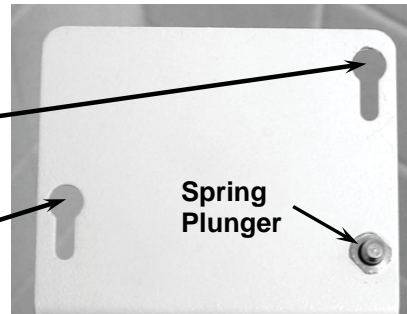

Figure No. 4



Figure No. 5

CHILD SEAT INSTALLATION

Before using the scale, it will be necessary to install the child seat. Follow the steps listed below to install the child seat.

PARTS LIST			TOOLS REQUIRED
Qty.	Part No.	Description	#1 Philips
(1)	6100-0025	Child Seat, White	
(1)	0033-C323-08	Gimbal for 8432-CH Child Seat	
(4)	6021-1423	1/4-20 X 1/2" Truss Head Screws	
(4)	6021-1553	#10-24 X 1/2" Truss Head Screws	

1. Remove child seat and hardware kit (plastic bag with screws) from box.
2. Remove child seat gimbal from packing.



3. Remove mounting screws from plastic bag.

1/4-20 x 1/2" screws
(gimbal to platform)



#10-24 x 1/2" screws
(seat to gimbal)

4. Determine which direction child seat is to face, left or right side of scale or forward (away from indicator) and place gimbal on scale.



CHILD SEAT INSTALLATION, CONT.

5. Align the holes in the gimbal with the holes in the scale platform, and attach the gimbal to the scale platform with the four 1/4-20 x 1/2" screws.
6. Using the Philips screw driver, tighten the screws.

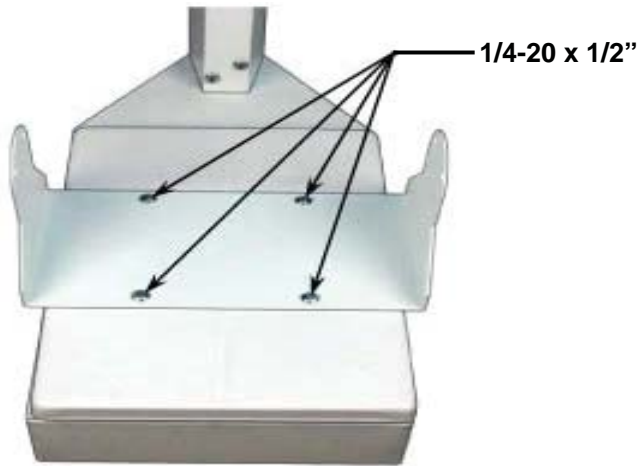

7. After the gimbal is installed, position the child seat in the gimbal and attach with the #10-24 x 1/2" screws (two screws on each side of the gimbal).

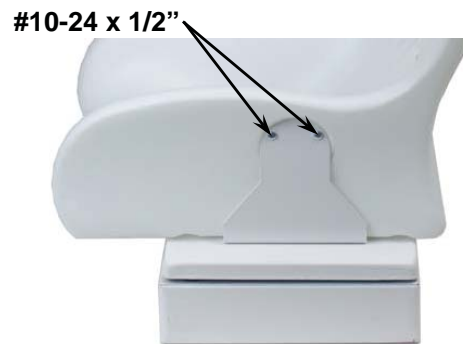

8. Periodically re-check the screws for tightness.



AC POWER ADAPTER

To power the scale using the optional 110-240V AC 50/60 Hz 12V DC wall plug-in AC power adapter, connect the small round plug from the AC adapter into the power jack on the back of the indicator and then plug the AC power adapter into the proper electrical outlet. Refer to Figure 1. On models requiring 240V AC, it is the customer's responsibility to obtain the correct AC power adapter plug.

BATTERY OPERATION

Batteries

The scale can use 6 "AA" size Alkaline, Ni-Cad or NiMH batteries (*not included*). You must first obtain and install batteries before operations can begin. Batteries are contained in a battery holder inside indicator. Access is via a removable panel on the back of indicator.

When using batteries, all 6 batteries must be of the same type. They must be all Alkaline, Ni-Cad or all NiMH. In addition, **DO NOT** mix Ni-Cad or NiMH batteries.



IMPORTANT! The scale can be operated from Alkaline, Ni-Cad or NiMH batteries. All six (6) batteries must be of the same type. They must all be Alkaline, all Ni-Cad or all NiMH. **DO NOT** mix Alkaline and Ni-Cad or NiMH batteries.



CAUTION! The AC power adapter is also used to recharge the batteries, when the scale is operated from Ni-Cad or NiMH batteries. **DO NOT** connect the AC power adapter if using alkaline batteries. Also, when using alkaline batteries, make sure the *recharge* setup option is disabled (set to 0). Refer to Setup and Calibration or Setup Review sections of 750 Weight Indicator Owner's Manual (8555-M483-O1).

Battery Status

The 750 indicator will operate for up to 250 hours on new Alkaline batteries or for up to 100 hours on fully charged Ni-Cad or NiMH batteries depending on the condition of the batteries (from new to about 500 recharges). The battery bar graph on the display indicates the battery capacity in 4 steps:



- 4 segments - the full battery capacity is available,
- 3 segments - the battery is at 75% of capacity,
- 2 segments - the battery is at 50% of capacity,
- 1 segment: - the battery is at 25% capacity.

When the battery voltage drops too low for accurate weighing, the indicator will show *LoBat* and then shut off. You will be unable to turn the indicator back on until the Alkaline batteries have been replaced or if using Ni-Cad or NiMH batteries, the AC power adapter is connected to the display to operate it and recharge the batteries.

Battery Charging

To recharge the Ni-Cad or NiMH batteries, the AC power adapter must be connected to a power outlet and plugged into the indicator. It will take approximately 8 to 10 hours to fully recharge the batteries in the display. Charging the batteries for more than 10 hours *will not* damage them. **NOTE:** The indicator may be operated while the batteries are charging.

BATTERY OPERATION, CONT.

Battery Installation/Replacement

To install or remove the batteries, the following steps should be followed:

1. Make sure the AC power adapter is unplugged.
2. Remove the indicator from the scale column bracket. (Referring to Figure No. 6, pull the spring plunger down and slide the indicator up and away from the bracket).
3. Turn the indicator over so that the display is facing away from you.
4. Locate the rectangular panel on the back of the indicator.
5. To install or replace the batteries, first remove the battery holder cover by pushing in on the tab and lifting it up. Refer to Figure No. 7.
6. If installing new batteries, proceed to step 7. If replacing the batteries, remove all 6 batteries from the battery holder and then proceed to step 7.
7. Install the 6 new “AA” size batteries in the battery holder, noting the polarity markings located in the battery holder. Refer to Figure No. 8.
8. After placing all 6 batteries in the holder, replace the battery cover.
9. Turn the indicator over (display facing up) and press the **ON/OFF** key.
10. If the display turns on, the batteries have been installed correctly. If not, remove the panel and check for one or more improperly positioned batteries.
11. Return the indicator to the scale column bracket. Refer to the steps on page 3.
12. The scale is now ready for operation.



Figure No. 6

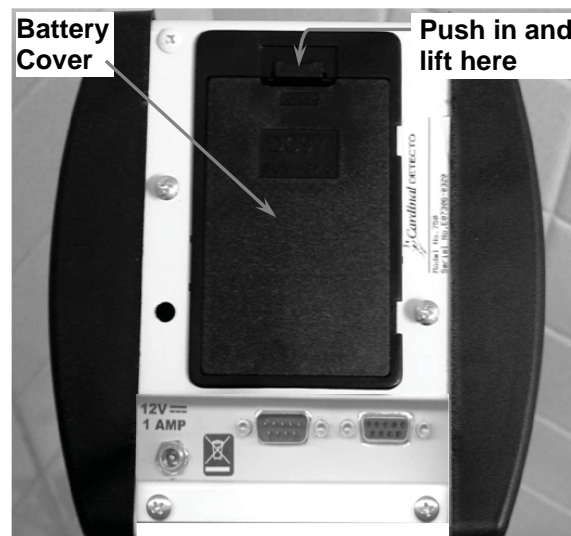

Figure No. 7

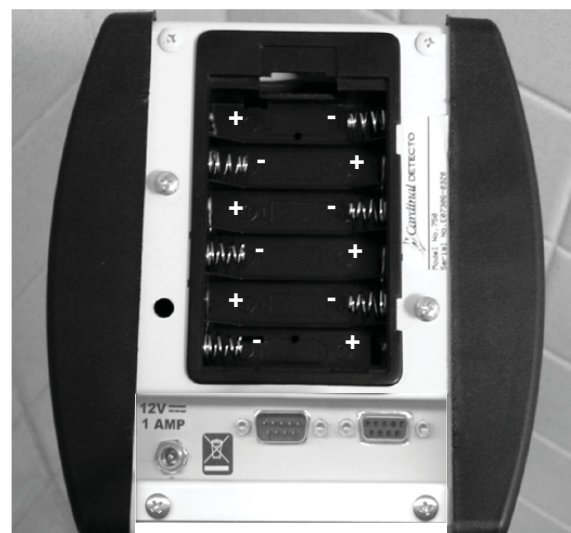

Figure No. 8

For more information on setup and operation of the indicator, see the 750 Owner's Manual (8555-M483-O1).

OPERATION

CAUTION!



Do not leave the child unattended in the child seat. Failure to maintain continual control of the child can result in serious injuries should the child fall from the child seat.

NOTE! The seat straps have been intentionally omitted!

Basic Weighing



1. Place scale on a level, stable surface.
2. With the child seat empty, press the **ON/OFF** key to turn on the indicator.
3. If required, press the **ZERO** key to zero the weight display.
4. Place the child being weighed in the center of the child seat. This will distribute the weight evenly across the scale platform.
5. When the weight is stable (STABLE ) annunciator will turn on), read the weight display.
6. If a printer is connected to the scale, press the **PRINT** key to print a ticket.
7. Remove the child from the child seat.





Figure No. 9

Zero Weight Display

1. If the indicator display is not showing zero weight, press the **ZERO** key.
2. Weight display will return to zero. ZERO and STABLE  annunciators will turn on to show a stable, center-of-zero ($\rightarrow 0 \leftarrow$) weight condition.

Zero Weight Display with Item on Scale

1. Place the item (blanket or similar covering) in the child seat.
2. The display will show the weight of the item in the child seat.
3. Press the **ZERO** key.
4. The weight display will return to zero. ZERO and STABLE  annunciators will turn on. The weight of the item has been "zeroed off".
5. Place the child being weighed in the center of the child seat. This will distribute the weight evenly across the scale platform.
6. When the weight is stable (STABLE ) annunciator will turn on), read the weight display.
7. If a printer is connected to the scale, press the **PRINT** key to print a ticket.
8. Remove the child from the child seat.

REPLACEMENT PART IDENTIFICATION

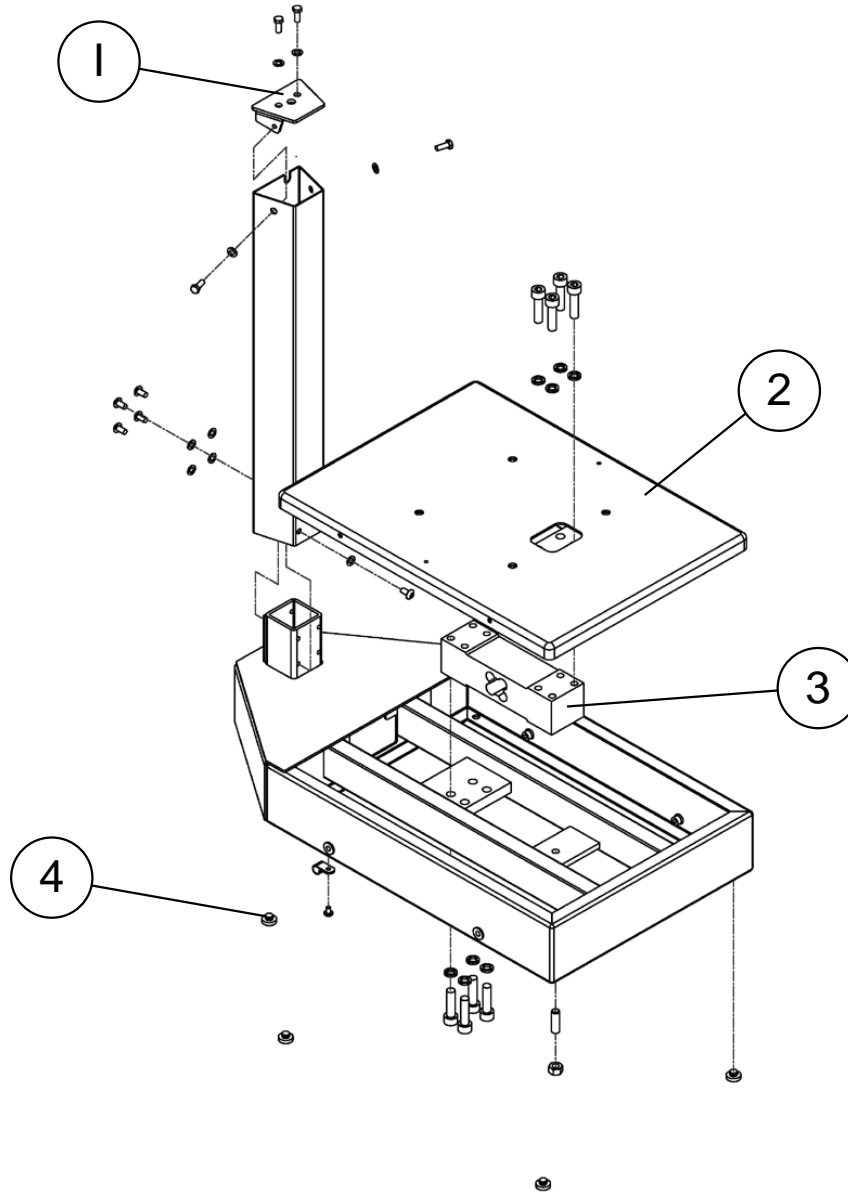

Item	Qty.	Part Number	Description
1	1	0033-0532-0A	TOP PLATE ASSY
2	1	0033-0533-0A	PLATFORM ASSY
3	1	0033-0534-0A	LOAD CELL ASSY
4	1	0033-0546-08	BASE FEET
*	1	750	DIGITAL WEIGHT INDICATOR

* Not Shown

STATEMENT OF LIMITED WARRANTY

DETECTO warrants its equipment to be free from defects in material and workmanship as follows: DETECTO warrants to the original purchaser only that it will repair or replace any part of equipment which is defective in material or workmanship for a period of **two (2) years from date of shipment**. Detecto shall be the sole judge of what constitutes a defect.

During the **first ninety (90) days** DETECTO may choose to replace the product at no charge to the buyer upon inspection of the returned item.

After the first ninety (90) days, upon inspection of the returned item, DETECTO will repair or replace it with a remanufactured product. The customer is responsible for paying for the freight both ways.

This warranty does not apply to peripheral equipment not manufactured by DETECTO; this equipment will be covered by certain manufacturer's warranty only.

This warranty does not include replacement of expendable or consumable parts. This does not apply to any item which has deteriorated or damaged due to wear, accident, misuse, abuse, improper line voltage, overloading, theft, lightning, fire, water or acts of God, or due to extended storage or exposure while in purchaser's possession. This warranty does not apply to maintenance service. Purchased parts will have a ninety (90) day repair or replacement warranty only.

DETECTO may require the product to be returned to the factory; item(s) must be properly packed and shipping charges prepaid. A return authorization number must be obtained for all returns and marked on the outside of all returned packages. DETECTO accepts no responsibility for items lost or damaged in transit.

Conditions Which Void Limited Warranty

This warranty shall not apply to equipment which:

- A.) Has been tampered with, defaced, mishandled or has had repairs and modifications not authorized by DETECTO.
- B.) Has had serial number altered, defaced, or removed.
- C.) Has not been properly grounded according to Detecto's recommended procedure.

Freight Carrier Damage

Claims for equipment damaged in transit must be referred to the freight carrier in accordance with freight carrier regulations.

This warranty sets forth the extent of our liability for breach of any warranty or deficiency in connection with the sale or use of the product. DETECTO will not be liable for consequential damages of any nature, including but not limited to, loss of profit, delays or expenses, whether based on tort or contract. Detecto reserves the right to incorporate improvements in material and design without notice and is not obligated to incorporate improvements in equipment previously manufactured.

The foregoing is in lieu of all other warranties, express or implied including any warranty that extends beyond the description of the product including any warranty of merchantability or fitness for a particular purpose. This warranty covers only those DETECTO products installed in the forty-eight (48) contiguous continental United States.



Ph. (800) 641-2008
E-mail: detecto@cardet.com
102 E. Daugherty
Webb City, MO 64870

04/22/2024
Printed in USA
D268-WARRANTY-DET-B



DETECTO
102 E. Daugherty, Webb City, MO 64870 USA
Ph: 417-673-4631 or 1-800-641-2008
Fax: 417-673-2153
www.Detecto.com
Technical Support: 1-866-254-8261
E-mail: tech@cardet.com