

DETECTO®



MODEL PS7

Digital Portion Scale

With Check Weighing Mode
Owner's Manual

INTRODUCTION

Thank you for purchasing our Detecto Model PS7 Digital Portion Scale. The PS7 is equipped with a Stainless-Steel platform that is easily removed for cleaning. With the included 15V DC adapter, the scale can be used in a fixed location or with the rechargeable battery as a portable scale.

This manual will guide you through installation, and operation of your scale. Please read it thoroughly before attempting to operate this scale and keep it handy for future reference.

FCC COMPLIANCE STATEMENT

This equipment generates, uses and can radiate radio frequency, and if not installed and used in accordance with the instruction manual, may cause interference to radio communications. It has been designed within the limits for a Class A computing device pursuant to Subpart J of Part 15 of FCC rules to provide reasonable protection against such interference when operated in a commercial environment. Operation of this equipment in a residential area may cause interference in which case the user will be responsible to take whatever measures necessary to correct the interference.

COPYRIGHT

All rights reserved. Reproduction or use, without expressed written permission, of editorial or pictorial content, in any manner, is prohibited. No patent liability is assumed with respect to the use of the information contained herein.

DISCLAIMER

While every precaution has been taken in the preparation of this manual, the Seller assumes no responsibility for errors or omissions. Neither is any liability assumed for damages resulting from use of the information contained herein. All instructions and diagrams have been checked for accuracy and ease of application; however, success and safety in working with tools depend to a great extent upon the individual accuracy, skill and caution. For this reason, the Seller is not able to guarantee the result of any procedure contained herein. Nor can they assume responsibility for any damage to property or injury to persons occasioned from the procedures. Persons engaging the procedures do so entirely at their own risk.

Serial Number _____ Date of Purchase _____ Purchased Form _____
--

RETAIN THIS INFORMATION FOR FUTURE USE

TABLE OF CONTENTS

- Installation 1
 - Unpacking 1
 - Power Supply 1
 - Battery 1
 - Battery Charging 1
 - Installing A Replacement Battery 2
 - Low Battery (LoBAt) 2
- Display Annunciators 3
- Key Functions 4
- Operation 5
- Check Weighing 6
 - Set the Under and Over Limit Weights 6
- Check Weighing Operation 7
- Configuration 8
- Gravity Compensation 10
- Display Messages 11
- Care and Maintenance 11

SPECIFICATIONS

Weight Display:	1.0-inch (25mm) backlit LCD, 5 Digit with fraction
Dimensions:	8.03" W x 7.87" D x 2.44" H (204mm x 200mm x 62mm)
Platform Size:	8.02" W x 4.96" D (203.8mm x 126mm)
Zero:	Established on power up routine and maintained by auto-zero circuitry.
Power:	115 VAC 50/60Hz or 230 VAC 50/60 Hz powering a 15 VDC 300 mA wall plug-in UL/CSA listed power supply or one (1) rechargeable battery.
Tare (Zero):	100% of scale capacity
Temperature:	40° to 105°F (5° to 40°C)
Humidity:	25% ~95% RH
Capacity:	7lb x 0.1oz, 112 oz x 0.1oz, 112 oz x 1/8 oz, 3000g x 1g 7 lb x 0.005 lb
Keys:	ON/OFF, MODE/OK, UNIT/▶, TARE/⚡/▲
Features:	Low battery indicator, power saving selectable timing, auto shut-off

PRECAUTIONS

Before using this instrument, read this manual and pay special attention to all "WARNING" symbols:



INSTALLATION

Unpacking

Before beginning installation of your scale, make certain the instrument has been received in good condition. When removing the scale from its packing, inspect it for signs of damage, such as exterior dents and scratches. Keep the carton and packing material for return shipment if it should become necessary. It is the responsibility of the purchaser to file all claims for any damages or loss incurred during transit.

1. Remove the scale from the shipping carton and inspect it for any signs of damage.
2. Plug-in the 15VDC adapter or use the internal rechargeable battery pack. Refer to the POWER SUPPLY or BATTERY sections of this manual for more instructions.
3. Place the scale on a flat level surface, such as a table or bench.
4. The scale is now ready for use.

Power Supply

To apply power to the scale using the supplied 15VDC, 300 mA power supply, insert the plug from the power supply cable into the power jack on the back of the scale and then plug power supply into the proper electrical outlet. The scale is now ready for operation.

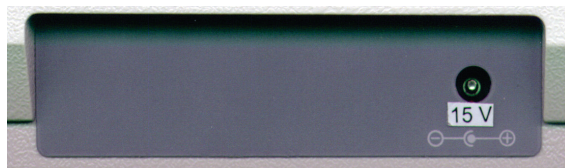

Battery

The scale is shipped with an internal rechargeable battery pack (7.2VDC, 700 mA). The battery is contained in a cavity inside the scale. Access is via a removable cover on the bottom of the scale. The PS7 can operate for up to 20 hours of continuous use with a fully charged battery pack. Full charging the rechargeable battery pack before the first use is necessary.

Battery Charging

To recharge the battery pack, the power supply must be connected to an AC power outlet and plugged into the scale. It will take approximately 8.5 hours to fully recharge the battery pack in the scale. While the batteries are charging the PS7 can still be operated.



Red light: The battery is charging.

Green light: The battery is fully charged.

When the scale is connected to the AC power supply, the charging light will flash three (3) times between Red and Green and then turn Red and stay on indicating the battery is charging. Note that if the battery is not connected to the scale, the charging light will turn off after flashing between Red and Green.

Charging the battery pack for more than 8.5 hours *will not* damage it but the lifetime of rechargeable battery pack may be shortened.

If the power supply is disconnected before the 8.5 hours, the scale will continue to charge the battery pack when the power supply is plugged back in.

INSTALLATION, CONT.

Installing a Replacement Battery

When the scale cannot be operated by a full charged rechargeable battery pack well (continue to show *LoBat* or automatically shut off during operation or not switch on), it's time to replace the rechargeable battery pack.

1. Turn scale over so that display is facing down and place it upside down on a flat level surface, such as a table or bench.
2. Locate battery cover on bottom of scale.
3. Remove cover by pushing in on tab and pulling up exposing battery snap connector.
4. Remove old battery and disconnect power cable and then connect new battery.
5. Replace cover (it will click when locked in place) and return scale to upright position.
6. Check scale for proper operation.

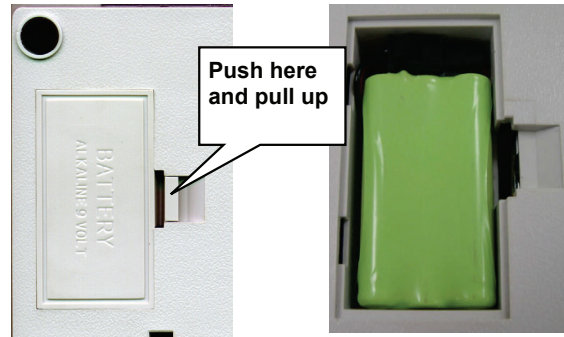

Low Battery (*LoBat*)

When the rechargeable battery pack is near the point it needs to be recharged, a low battery indicator on the display will turn on. If the battery voltage drops too low for accurate weighing, the scale will automatically shut off and you will be unable to turn it back on. When the low battery indicator is displayed, the operator should plug-in the 15VDC adapter.

DISPLAY ANNUNCIATORS

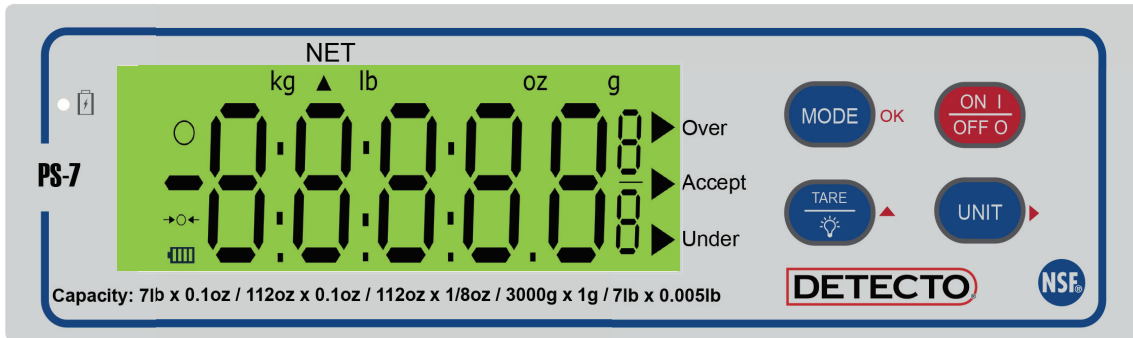

The annunciators are turned on to indicate that the scale display is in the mode corresponding to the annunciator label or that the status indicated by the label is active.

O

The O annunciator is turned on when the weight display is stable.

lb

The lb annunciator is turned on to indicate that the displayed weight is in pounds.

oz

The oz annunciator is turned on to indicate that the displayed weight is in ounces.

lb / oz

Both the lb and oz annunciators are turned on to indicate that the displayed weight is in pounds and ounces.

oz 1/8

The oz 1/8 annunciator is turned on to indicate that the displayed weight is in 1/8 ounce.

g

The g annunciator is turned on to indicate that the displayed weight is in grams.

NET

Activated with the TARE function, the NET annunciator indicates that the displayed weight is the net weight on the scale.

NOTE: The following annunciators are only active when in the Check Weighing Mode.

OVER

This annunciator triangle is turned on, and the display backlight will turn RED to signal that the weight is greater than the Over Limit weight setting.

ACCEPT

This annunciator triangle is turned on, and the display backlight will turn GREEN to signal that the weight is within the acceptable target limits (between the Under and the Over Limit settings).

UNDER

This annunciator triangle is turned on (with NO display backlight) to signal that the weight is less than the Under Limit setting.

KEY FUNCTIONS

ON/OFF

1. Press and release the **ON/OFF** key to turn ON the scale.
2. Press and release the **ON/OFF** key to turn the scale OFF.
3. Press the **ON/OFF** key to confirm setting in Gravity Compensation mode.

MODE/OK

1. Press and hold the **MODE/OK** key to enter the Check Weighing Mode. The scale will beep twice.
2. Press and hold the **MODE/OK** key to exit the Check Weighing Mode and return to the Normal Weighing Mode. The scale will beep once.

UNIT/▶

1. Press the **UNIT** key to change the weighing units to the alternate units of measurement (if selected during configuration of the scale).
2. In Check Weighing Mode, the **UNIT** key is used to advance to the next digit when entering the Under and Over Limit weights.
3. Press the **UNIT** key to select menu in the Configuration mode.

TARE/💡/▲

1. Press the **TARE** key to zero the weight display or to tare the weight of a container (ex: a pan or a plate) up to the full capacity of the scale.
2. In Check Weighing Mode, the **TARE** key is used to increase the value of the blinking digit from 0 to 9 when entering the Under and Over Limit weights.
3. Press and hold the **TARE** key and the **ON/OFF** key for 3 seconds to enter the Configuration mode.
4. Press the **TARE** key to confirm the setting for each menu.
5. In Gravity Compensation mode, press the **TARE** key to choose number from 0~9.

OPERATION



The membrane keyboard is not to be operated with pointed objects (pencils, pens, fingernails, etc.). Damage to keyboard resulting from this practice will **NOT** be covered under warranty.

Turn the Scale On

Press the **ON/OFF** key to turn the scale on. The scale will display *00000* then change to the selected weighing units.

Change the Weighing Unit

Press the **UNIT** key to alternate between the selected weighing units.

NOTE: Multiple weighing units must be enabled during configuration for this function to be operational.

Weighing

Place the item to be weighed on the scale tray, wait a moment for the scale display to stabilize and then read the weight.

To Zero the Weight Display

To zero the weight display, press the **TARE** key and continue. Note that the scale will zero (Tare) until the full capacity of the scale is reached.

Display Backlight

The PS7 is equipped with a back lit display. The display backlight will be turned on during weighing and will automatically turn off 5 seconds after the weight has been removed from the scale.

Enable Backlight

To turn the backlight ON, press the **TARE** key and hold for 3 seconds. The scale will beep indicating the backlight has been turned ON.

Disable Backlight

Press the **TARE** key and hold for 3 seconds. The scale will beep indicating the backlight has been turned OFF.

NOTE: The backlight mode is stored in memory and will restored when the scale is switched off and back on again.

CHECK WEIGHING

The PS7 allows you to set up the target accept settings for check weighing. The keyboard is used to enter your Over and Under check weight limits.

Set the Under and Over Limit Weights

1. Press the **ON/OFF** key to turn the scale on.
2. The scale will display **88888** then change to the Normal Weighing Mode.
3. Press and hold the **MODE** key until the scale beeps twice to enter the Check Weighing Mode.
4. With the scale in Check Weighing Mode, the first digit on the display will be flashing.
5. Press the **TARE** key to change the value of this digit from 0 to 9.
6. Press the **UNIT** key to switch to the next digit, and then press the **TARE** key to change the value of this digit from 0 to 9.
7. Repeat step 3 until the desired Under Limit weight has been entered.
8. Once the desired Under Limit weight has been entered, press the **MODE/OK** key to save it and advance to Over Limit weight setting.
9. After pressing the **MODE/OK** key to save the Under Limit setting, the scale will beep twice, the backlight will turn on (RED), and the first digit on the display will be flashing.
10. Press the **TARE** key to change the value of this digit from 0 to 9.
11. Press the **UNIT** key to switch to the next digit, and then press the **TARE** key to change the value of this digit from 0 to 9.
12. Repeat step 3 until the desired Over Limit weight has been entered.
13. Once the desired Over Limit weight has been entered, press the **MODE/OK** key to save it.
14. The scale will beep twice, and is now ready for Check Weighing operation.



NOTE: In Check Weighing Mode, the **UNIT** key function is disabled. Note that the **TARE** key is enabled to tare the container weight (ex: a pan or a plate) or zero the display.

To exit the Check Weighing Mode and return to the Normal Weighing Mode, press the **MODE** key. The scale will beep once, and the Under annunciator triangle will turn off.

CHECK WEIGHING OPERATION

Weight Less Than Under Limit Setting

If the displayed weight is less than the Under Limit setting, the Under annunciator triangle will turn on, with NO backlight. Note that the scale will beep slowly when the weight is within 90% of the Under Limit weight setting.

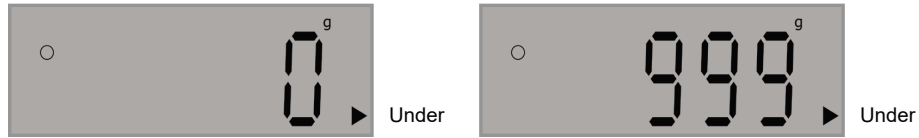

Weight Is Within Acceptable Limits

When the weight is within the acceptable target limits (the weight is between the Under Limit and the Over Limit settings), the Accept annunciator triangle will turn on, the display backlight will turn GREEN, and the scale will beep twice (after the weight is stable).

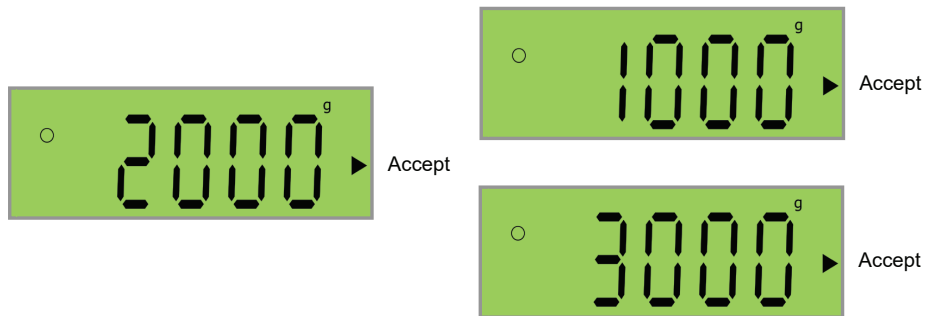

Weight Greater Than Over Limit Setting

This annunciator is turned on, the display backlight will turn RED, and the scale will beep *continuously*, to signal that the weight is greater than the target Over Limit weight setting.

NOTE: The display will also show *Err* (with a RED display backlight) and the scale will beep three times when the weight is greater than the Over Limit weight setting.

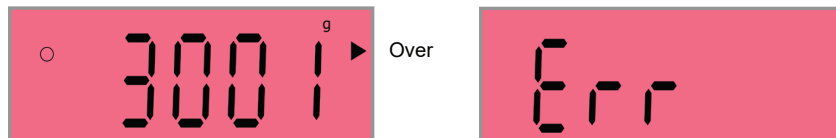

CONFIGURATION

Your scale has been pre-configured at the factory and should not require configuration for use in most applications. In the event that the factory settings do not meet the requirements of your application, the following describes the steps to configure the scale.

To Begin Configuration

1. Press and hold the **TARE** key and the **ON/OFF** key for approximately 3 seconds.
2. When the display shows $5\bar{E}t$, release the keys to enter the Configuration mode. The display will change to show $Un\bar{t}$.

NOTE: Pressing the **UNIT** key will step through the configuration parameters until $E\bar{n}d$ is displayed. When the display changes to $E\bar{n}d$, press the **TARE** key to save the configuration parameters and return to normal weighing mode

WEIGHING UNITS

To select “lb and OZ” (pounds and ounces) weighing units:

1. With the display showing $Un\bar{t}$, press the **TARE** key to enter select unit function. The display will change to show both the “lb” and “OZ” annunciators turned on.
2. Press the **TARE** key to display the “lb and OZ” status.
3. Press the **UNIT** key to toggle between:
 - Enabled (display will change to On)
 - Disabled (display will change to OFF).
4. Press the **TARE** key and then the **UNIT** key 5 times.
5. The display will change to $Un\bar{t}$.
6. Proceed to **AUTOMATIC SHUTOFF**.

To select “OZ” (ounce only) weighing units: show On , and

1. With the display showing $Un\bar{t}$, press the **TARE** key and then the **UNIT** key. The display will change to show On , and turn on the “OZ” annunciator.
2. Press the **TARE** key to display the OZ status.
3. Press the **UNIT** key to toggle between:
 - Enabled (display will change to On)
 - Disabled (display will change to OFF).
4. Press the **TARE** key and then the **UNIT** key 4 times.
5. The display will change to $Un\bar{t}$.
6. Proceed to **AUTOMATIC SHUTOFF**.

To select “1/8 OZ” (fractional ounce) weighing units:

1. With the display showing $Un\bar{t}$, press the **TARE** key and then the **UNIT** key 2 times. The display will change to show “1/8”, and turn on the “OZ” annunciator.
2. Press the **TARE** key to display the “1/8 OZ” status.
3. Press the **UNIT** key to toggle between:
 - Enabled (display will change to On)
 - Disabled (display will change to OFF).
4. Press the **TARE** key and then the **UNIT** key 3 times.
5. The display will change to $Un\bar{t}$.
6. Proceed to **AUTOMATIC SHUTOFF**.

CONFIGURATION, CONT.

To select “g” (gram) weighing units:

1. With the display showing *U n t*, press the **TARE** key and then **UNIT** key 3 times. The display will change to show the “g” annunciator turned on.
2. Press the **TARE** key to display the “g” (gram) status.
3. Press the **UNIT** key to toggle between:
 - Enabled (display will change to *U n*)
 - Disabled (display will change to *OFF*).
4. Press the **TARE** key and then the **UNIT** key 2 times.
5. The display will change to *U n t*.
6. Proceed to **AUTOMATIC SHUTOFF**.

To select “lb” (pounds only) weighing units:

1. With the display showing *U n t*, press the **TARE** key and then **UNIT** key 4 times. The display will change to show the “lb” annunciator turned on.
2. Press the **TARE** key to display the “lb” status.
3. Press the **UNIT** key to toggle between:
 - Enabled (display will change to *U n*)
 - Disabled (display will change to *OFF*).
4. Press the **TARE** key and then the **UNIT** key.
5. The display will change to *U n t*.
6. Proceed to **AUTOMATIC SHUTOFF**.

AUTOMATIC SHUTOFF

1. With the display showing *U n t*, press the **UNIT** key. The display will change to show *ROFF*.
2. Press the **TARE** key to begin selection of the automatic shut-off time (in seconds). The display will change to show the current setting.
3. Press the **UNIT** key to toggle through the selections, *120*, *180*, *240*, *300*, or *OFF*.
4. When the desired time is displayed, press the **TARE** key.
5. The display will change to show *ROFF*.
6. Proceed to **BUZZER (BEEPER)**.

BUZZER (BEEPER)

1. With the display showing *ROFF*, press the **UNIT** key.
2. The display will change to show *bUrr*.
3. Press the **TARE** key to display the buzzer (beeper) status.
4. Press the **UNIT** key to toggle between:
 - Enabled (display will change to *U n*)
 - Disabled (display will change to *OFF*).
5. Press the **TARE** key and then the **UNIT** key.
6. Proceed to **GRAVITY COMPENSATION**.

CONFIGURATION, CONT.

GRAVITY COMPENSATION

1. With the display showing *bUrr*, press the **UNIT** key.
2. The display will change to show *GrAU*.
3. Press the **TARE** key to show the Gravity compensation mode status.
4. Press the **UNIT** key to toggle between:
 - Enabled (display will change to *On*)
 - Disabled (display will change to *OFF*).
5. Press the **TARE** key and then the **UNIT** key.
6. The display will change to show *End*.
7. Press the **TARE** key to save the settings, reset the scale, and return to normal weighing mode.
8. Setup is complete.

GRAVITY COMPENSATION

The Gravity Compensation for your scale has been pre-configured at the factory and should not require changing in most locations. In the event that the factory settings do not meet the requirements of your location, contact the factory for the value for your location.

With *GrAU* enabled in Configuration, the scale will use the factory set value of 9.7973 for the Gravity Compensation.

If the *GrAU* is disabled, the scale will use the value obtained from the factory and entered by the operator for the Gravity Compensation.

Change the Gravity Compensation Value

1. Press the **ON/OFF** key to turn on the scale.
2. Press and hold the **UNIT** key for approximately 3 seconds to enter the Gravity Compensation setting mode.
3. The display will change to show *Adj*, and then change to *9.7973* (or the current value) with the first decimal position blinking (the 7 in this example).
4. To enter the desired gravity value, press the **TARE** key to change the value of this digit from 0 to 9.
5. Press the **UNIT** key to switch to the next digit, and then press the **TARE** key to change the value of the digit from 0 to 9.
6. Repeat step 5 until the desired gravity value has been entered.
7. Press the **ON/OFF** key (to confirm the entered gravity value), and return the scale to the normal operating mode.

DISPLAY MESSAGES

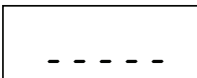
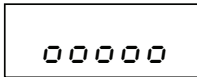
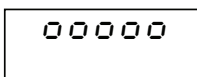
DISPLAY	MEANING
<i>LobAt</i>	Low battery indication
<i>ErrE</i>	E ² prom Error
<i>ErrL</i>	Zero count under 128
	Over capacity (upper dashes)
	Under capacity (lower dashes)
<i>ErrH</i>	Zero count over 25,000
<i>SPnH</i>	Calibration span too high
	Power-on zero count over calibration zero (+10%)
	Power-on zero count under calibration zero (-10%)

CARE AND MAINTENANCE

The heart of the PS7 Digital Portion Scale is a precision load cell located in the center of the scale base. It will provide accurate operation indefinitely if protected against overload of scale capacity, dropping items on scale, or other extreme shock.

- **DO NOT** submerge the scale in water, pour or spray water directly on it.
- **DO NOT** use acetone, thinner or other volatile solvents for cleaning.
- **DO NOT** expose scale to direct sunlight or temperature extremes.
- **DO NOT** place scale in front of heating/cooling vents.
- **DO** clean the scale with a damp soft cloth and mild non-abrasive detergent.
- **DO** remove power before cleaning with a damp cloth.
- **DO** provide clean AC power and adequate protection against lightning damage.
- **DO** keep the surroundings clear to provide clean and adequate air circulation.

STATEMENT OF LIMITED WARRANTY

DETECTO warrants its equipment to be free from defects in material and workmanship as follows: DETECTO warrants to the original purchaser only that it will repair or replace any part of equipment which is defective in material or workmanship for a period of **two (2) years from date of shipment**. Detecto shall be the sole judge of what constitutes a defect.

During the **first ninety (90) days** DETECTO may choose to replace the product at no charge to the buyer upon inspection of the returned item.

After the first ninety (90) days, upon inspection of the returned item, DETECTO will repair or replace it with a remanufactured product. The customer is responsible for paying for the freight both ways.

This warranty does not apply to peripheral equipment not manufactured by DETECTO; this equipment will be covered by certain manufacturer's warranty only.

This warranty does not include replacement of expendable or consumable parts. This does not apply to any item which has deteriorated or damaged due to wear, accident, misuse, abuse, improper line voltage, overloading, theft, lightning, fire, water or acts of God, or due to extended storage or exposure while in purchaser's possession. This warranty does not apply to maintenance service. Purchased parts will have a ninety (90) day repair or replacement warranty only.

DETECTO may require the product to be returned to the factory; item(s) must be properly packed and shipping charges prepaid. A return authorization number must be obtained for all returns and marked on the outside of all returned packages. DETECTO accepts no responsibility for items lost or damaged in transit.

Conditions Which Void Limited Warranty

This warranty shall not apply to equipment which:

- A.) Has been tampered with, defaced, mishandled or has had repairs and modifications not authorized by DETECTO.
- B.) Has had serial number altered, defaced, or removed.
- C.) Has not been properly grounded according to Detecto's recommended procedure.

Freight Carrier Damage

Claims for equipment damaged in transit must be referred to the freight carrier in accordance with freight carrier regulations.

This warranty sets forth the extent of our liability for breach of any warranty or deficiency in connection with the sale or use of the product. DETECTO will not be liable for consequential damages of any nature, including but not limited to, loss of profit, delays or expenses, whether based on tort or contract. Detecto reserves the right to incorporate improvements in material and design without notice and is not obligated to incorporate improvements in equipment previously manufactured.

The foregoing is in lieu of all other warranties, express or implied including any warranty that extends beyond the description of the product including any warranty of merchantability or fitness for a particular purpose. This warranty covers only those DETECTO products installed in the forty-eight (48) contiguous continental United States.



Ph. (800) 641-2008
E-mail: detecto@cardet.com
102 E. Daugherty
Webb City, MO 64870

04/22/2024
Printed in USA
D268-WARRANTY-DET-B



DETECTO
102 E. Daugherty, Webb City, MO 64870 USA
Ph: 417-673-4631 or 1-800-641-2008
Fax: 417-673-2153
www.Detecto.com
Technical Support: 1-866-254-8261
E-mail: tech@cardet.com